

## Q39794-6

### PNEUMA-CEL LOW PROFILE RETAINER KIT

#### KIT INCLUDES:

- (1) PR39794-A-6 RETAINER
- (2) 10-32 UNF x 3/8" LG FLATHEAD SOCKET SCREW
- (2) 10-32 UNF SLIDE-IN T-NUT
- (1) HEX, L-WRENCH, 1/8"

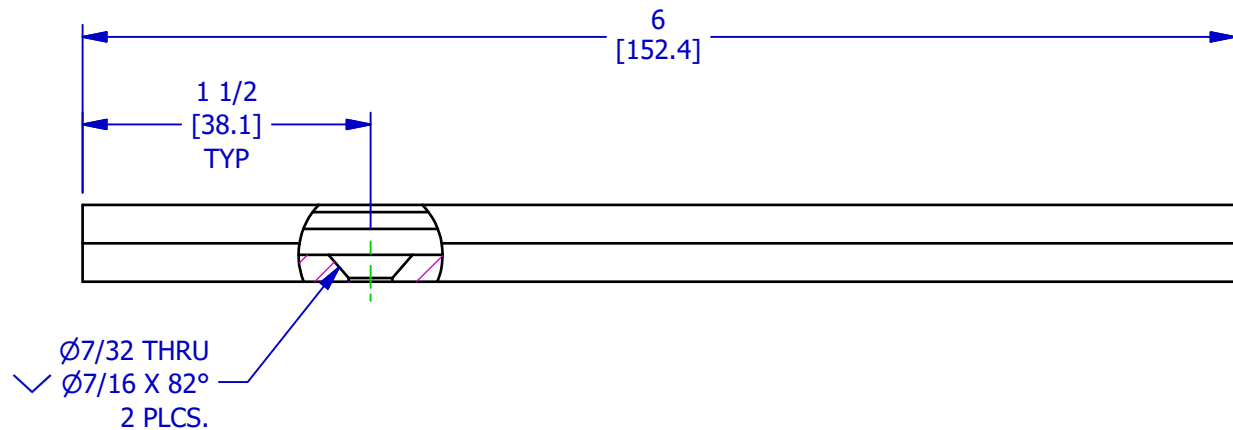
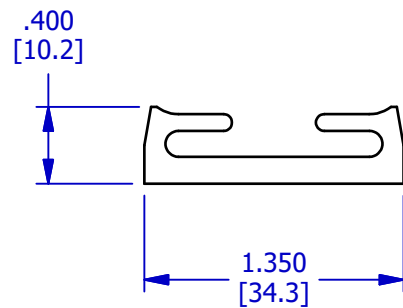
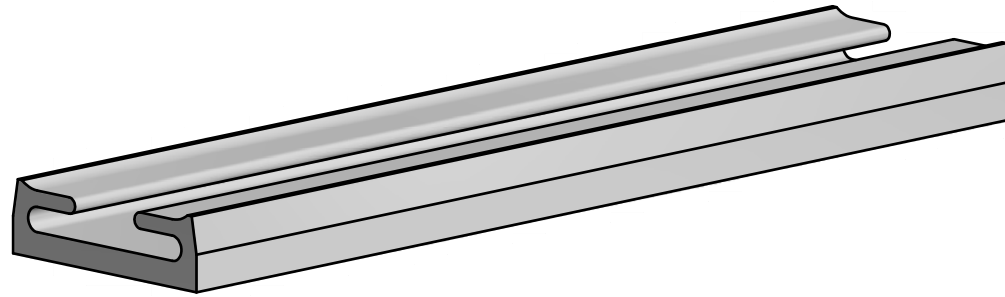

This design is the property of Pawling Engineered Products and is submitted in confidence. All rights reserved. Copying or imitation expressly prohibited. All or portions of this design may be subject to proprietary rights. This drawing is for reference only. Dimensions subject to change without prior notice.