

PRODUCT DETAIL



10-425 AUTOSAMPLER VIALS AND CAPS

AVAILABLE SEPTA:

- .040" (1mm) RED-WHITE SILICONE SEPTA, PRE-SLIT
- .040" (1mm) NT SERIES, LOW BLEED SILICONE SEPTA, PRE-SLIT
- .040" (1mm) NR SERIES, NATURAL RUBBER SEPTA
- .060" (1.5mm) RED-WHITE SILICONE SEPTA
- .060" (1.5mm) NT SERIES, LOW BLEED SILICONE SEPTA

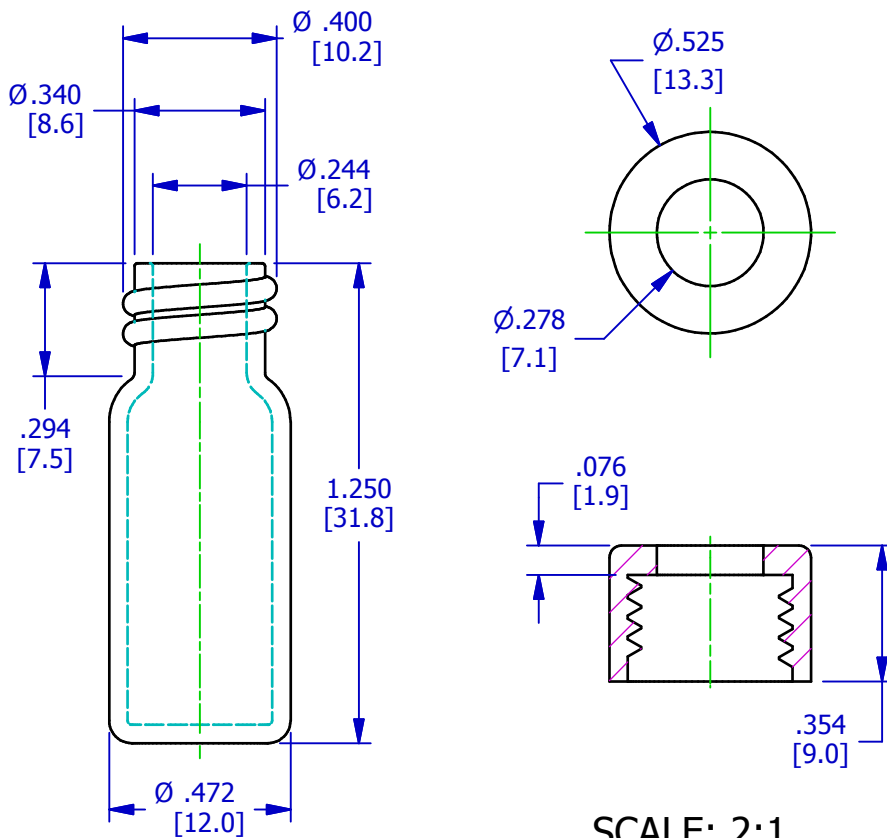

SCALE: 2:1

"This design is the property of Pawling Engineered Products and is submitted in confidence. All rights reserved. Copying or imitation expressly prohibited. All or portions of this design may be subject to proprietary rights. This drawing is for reference only. Dimensions subject to change without prior notice."