

X81211

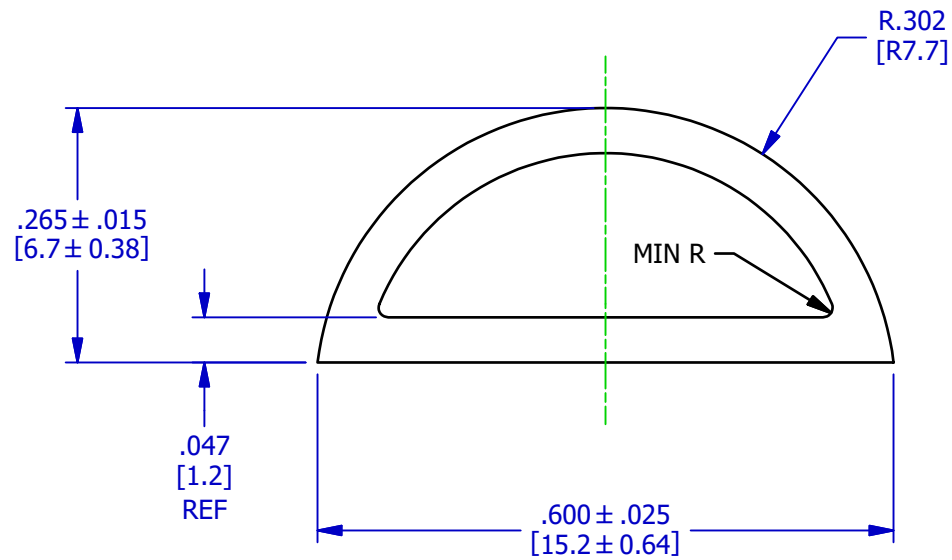

FULL SIZE

This design is the property of Pawling Engineered Products and is submitted in confidence. All rights reserved. Copying or imitation expressly prohibited. All or portions of this design may be subject to proprietary rights. This drawing is for reference only. Dimensions subject to change without prior notice.

Pawling Engineered Products, Inc.
157 Charles Colman Blvd.
Pawling, NY 12564

ph: (845) 855-1000
(800) 431-0101
fax: (845) 855-1139
pawlingep.com